

■ ■ ■ ■ ■ SIMALUBE



The new generation of long-term lubricators for grease and oil already in use worldwide in millions of applications.

Lubrication points can be lubricated automatically and cleanly with the correct lubricant quantity for up to one year. The traditional grease gun belongs to the past. Despite the simalube's 125 or 60 ml capacity, the compact size, light weight and complete range of accessories allows for installation in almost any place. It works in temperatures of -20° C up to +55° C, in any position, even under water.



INDUSTRIAL LUBRICANTS (UK)



**INDUSTRIAL LUBRICANTS (UK) LIMITED**

**Tel. 08701 632933 Fax. 08701 632933**

**sales@indlub.co.uk www.indlub.co.uk**



INDUSTRIAL LUBRICANTS (UK)

## ■ ■ ■ ■ ■ SIMALUBE applications



The **sima/lube** grease and oil dispenser is successfully used in the following industries:

- Machinery
- Food
- Paper
- Transport
- Hauling
- Mining, open-pit mining
- Textiles
- Wood
- Graphic
- Automotive
- Plastics
- Chemical
- Foundries
- Steel plants
- Mountain railways
- Construction



**sima/lube** fitted with square brush for chain lubrication



Elevator brush for lubricating elevator guide rails. The system is self-adjusting for rail widths of 5 - 16 mm.



Four-fold adapter with four lubricators for grease quantities of 500 ml.



**sima/lube** with mounting support and protective cover. Quick connection coupling with hose connection to the lubrication point.

## ■ ■ ■ ■ ■ SIMALUBE technical information

### Product specification

	<b>Simalube</b>	<b>Simalube (shorty)</b>
<b>Type:</b>	Automatic longterm grease and oil dispenser	
<b>Power generation:</b>	Hydrogen gas producing drycells	
<b>Working pressure:</b>	max. 3 bar	
<b>Content:</b>	125ml	60ml
<b>Adjustment:</b>	Stepless 1-12 months	
<b>Operating temperature:</b>	-20°C ... +55°C (-4°...+131°F) ambient temperature (note: grease consistency changes with temperature)	
<b>Operation / Usage:</b>	Grease dispenser can be installed in any position, even under water	
<b>Usage period:</b>	Within 2 years of filling date	
<b>Stock temperature:</b>	Recommended at 20°C +/- 5°C (65°F +/-10°F)	
<b>Weight full:</b>	~190g (~6.7 oz)	~115g (~4.1 oz)
<b>Weight empty:</b>	~75g (~2.7 oz)	~60g (~2.1 oz)
<b>Dimensions:</b>		

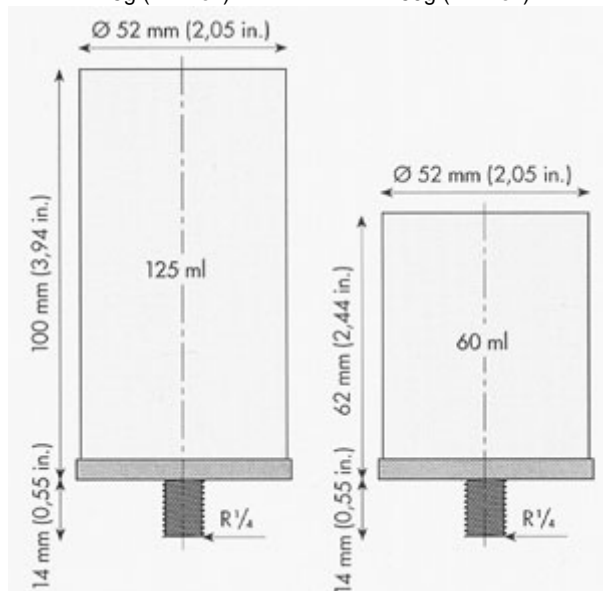
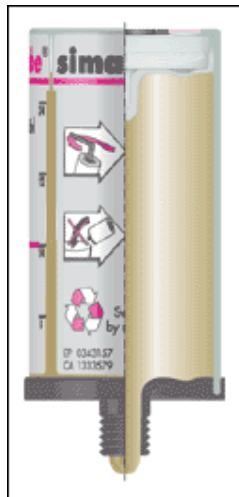

# ■ ■ ■ ■ ■ SIMALUBE greases / accessories

Available lubricants (Please ask us for the complete list of all the tested lubricants)

Nr.	Application	Temperature range °C	Base oil	Thickener	Oil viscosity at 40°C
SL 01	multipurpose grease	-30/+120	mineral oil	Li/Ca	118 mm <sup>2</sup> /s
SL 01	multipurpose grease with MoS <sub>2</sub>	-25/+130	mineral oil	Li	370 mm <sup>2</sup> /s
SL 04	high temperature grease	-20/+160	mineral oil	Be	555 mm <sup>2</sup> /s
SL 06	fluid grease	-40/+110	mineral oil	Li/Ca	98 mm <sup>2</sup> /s
SL 09	biodegradable grease *				
SL 10	food industry grease	-30/+140	synthetic	Al	400 mm <sup>2</sup> /s
SL 14	chain oil	-10/+90	mineral oil	-	68 mm <sup>2</sup> /s
SL 15	chain oil	0/+250	synthetic	-	265 mm <sup>2</sup> /s
SL 18	food oil	-10/+150	synthetic	-	222 mm <sup>2</sup> /s

Simalube are also with other lubricants or empty deliverable. You let inform by our.

## Accessoires

### Connection 45°

A= R1/4  
Nr. 1001

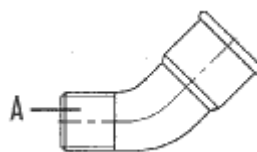

### Connection 90°

A= R1/4  
Nr. 1002

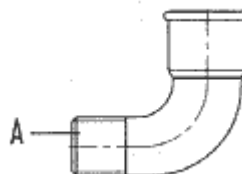

### Connection, straight

A= R3/8 R1/2  
Nr. 1010 1011

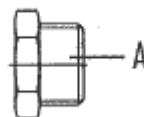

### Reduction

A=	R1/8	R1/4	M6	M8	M8x1
Nr.	1020	1021	1022	1023	1024
A=	M10	M10x1	M12	M12x1,5	
Nr.	1025	1026	1027	1028	

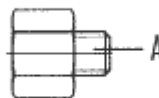

### Extension

A= 10 35 50  
Nr. 1021 1040 1041



### Y-Manyfold (contains reduction 1021)

A= R1/4  
Nr. 1050

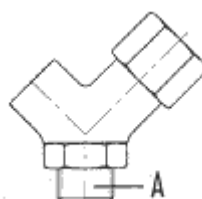

**Quick connection coupling** (for hose d=8mm)

A= R1/4  
Nr. 1060

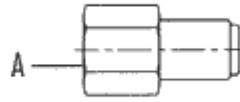

**Quick connection coupling** (for hose d=8mm)

A= R1/8 R1/4 R3/8  
Nr. 1070 1071 1072

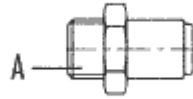

**Hose** (length to the lubrication point: max 0,5m) d=8 /6mm

A= per meter  
Nr. 2000/...m



**Clamb for Sima***lube*

A= 50  
Nr. 2010

[mm]

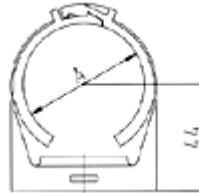

**Adapter for Perma clamb**

A= 28  
Nr. 2012

[mm]

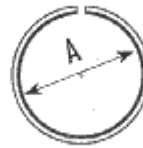

**Clamb for round brush**

A= 28  
Nr. 2013

[mm]

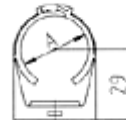

**Distance holder to clamb for round brush**

A= 15  
Nr. 2014

[mm]

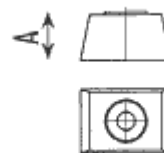

**Mounting support** (consisting of: Flange, connection straight R1/4, Nutt)

A=  
Nr. 2080

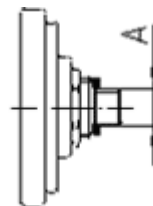

**Protection cover** (metal)

Nr. 2081

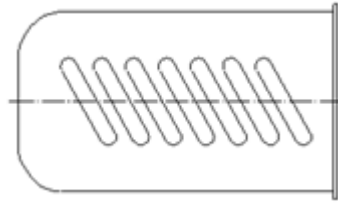

**Mounting bracket**

	1-fold lenght 75 mm	3-fold lenght 240 mm	5-fold lenght 390 mm
Nr.	2082	2083	2084

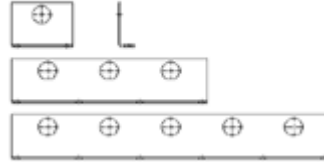

**Non-return valve (metal)**

A= R1/8 R1/4  
Nr. 2020 2021

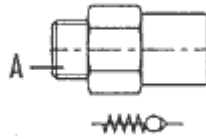

**Non-return valve plug (plastic)**

Nr. 5060

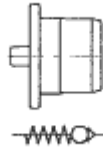

**Round brush**

AxL d=25x45  
Nr. 2034

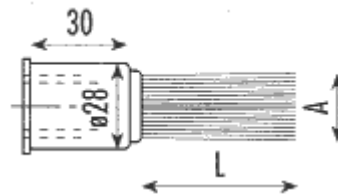

**Square brushes**

A=	25	40	70	100
Nr.	2038	2035	2036	2037

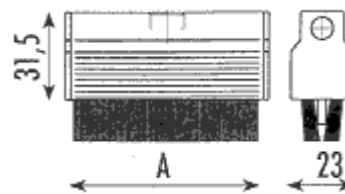

**Elevator brush**

Nr. 2039

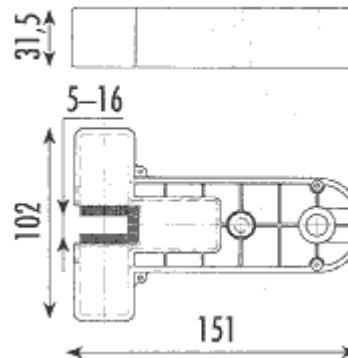

**Grease gun (with valve pipe)**  
DIN 1283



Nr. 3010

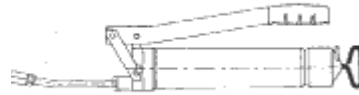

**Connector nipple** (for clearing and filling of grease lines)

A= R1/4

Nr. 3011

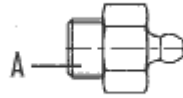

**Refill nipple** (for refilling of **Simalube**)

A= R1/4

Nr. 3012



**4fold adapter**

A= 1/2" 1/4"

Nr. 4100 4101

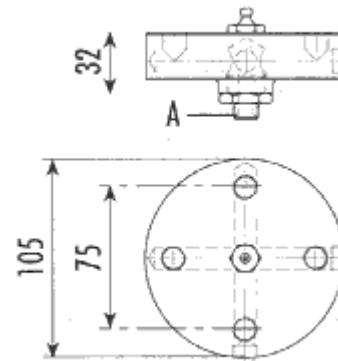

**Gas generator** (replacement)

**Simalube**

**Simalube** <shorty>

Nr. 5000

5002



**Cartouche** (DIN 1284; 400ml)

Fett SL01 SL02 SL04 SL06 SL09 SL10

Nr. KA01 KA02 KA04 KA06 KA09 KA10

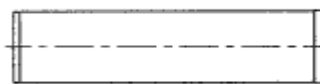

**Attention!** Use original accessories only. For applications other than standard, contact simatec **BEKA Nederland B.V.**